

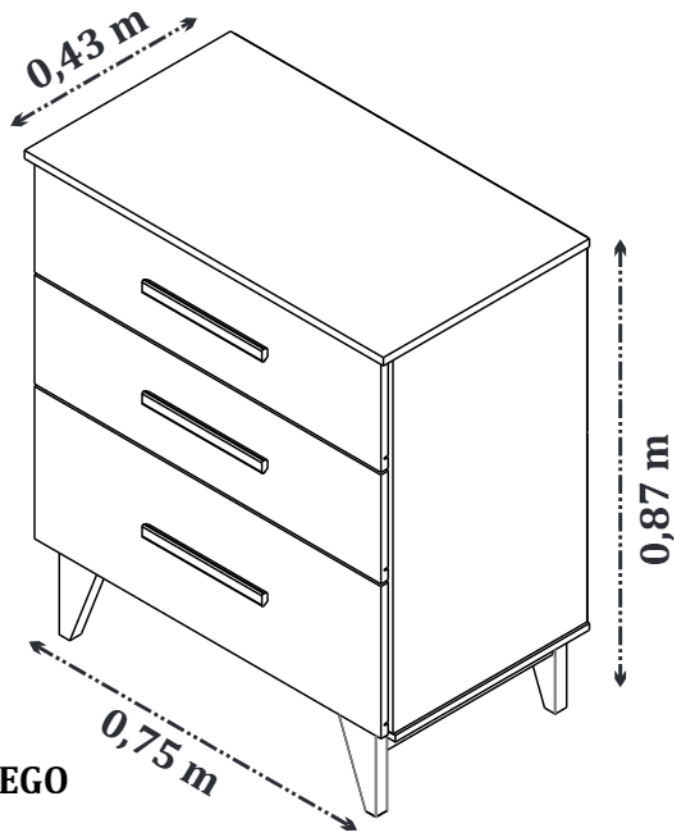

Qualidade para merecer você

## MANUAL DE MONTAGEM - CÔMODA 3 GAVETAS ACONCHEGO



**CÔMODA 3 GAVETAS ACONCHEGO**

**Cód.: 25818**

O fabricante se reserva ao direito de introduzir modificações técnicas em seus produtos, sem aviso prévio e sempre que julgar conveniente.

### NECESSÁRIO:



Chave Philips



Martelo



Pessoa necessária



Recomendamos que a montagem seja feita por um profissional capacitado.

**Tcil Móveis LTDA**  
**CNPJ 38.542.932/0001 39**  
**Rodovia Ubá - Guidoal, s/nºKm 01**  
**CEP- 36500-970**











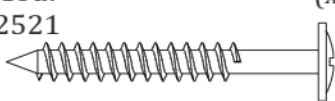

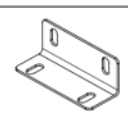
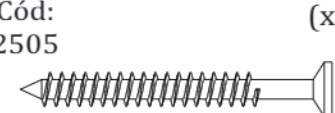
**IMPORTANTE:** Antes da montagem deste produto, confira todo conteúdo de peças e componentes conforme indicado abaixo. No caso de falta de peças, entre imediatamente em contato com a loja onde o mesmo foi comprado para resolução do problema. A não observância desta instrução, exime o fabricante de quaisquer responsabilidades futuras.

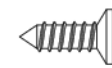
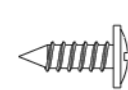
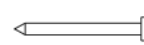
## LISTAGEM DE PEÇAS CÔMODA 3 GAVETAS ACONCHEGO

MEDIDAS EM mm

CÓDIGO DA PEÇA	QUANT.	DESCRIÇÃO	COMPRIMENTO	LARGURA	PROFUNDIDADE	TIPO DE MATERIAL
23170	1	LATERAL DIREITA	680	405	12	MDP 12MM
23171	1	LATERAL ESQUERDA	680	405	12	MDP 12MM
23172	1	BASE	749	405	12	MDP 12MM
23173	1	TAMPO	749	430	15	MDP 15MM
25833	2	FRENTE GAVETA	723	197	15	MDP 15MM
25821	1	FRENTE GAVETA MAIOR	723	275	15	MDP 15MM
13002	2	LATERAL GAVETA MAIOR	350	160	12	MDP 12MM
12990	4	LATERAL GAVETA	350	110	12	MDP 12MM
23158	2	TRASEIRO GAVETA	672	110	12	MDP 12MM
23187	1	TRASEIRO GAVETA MAIOR	672	160	12	MDP 12MM
23159	3	FUNDO GAVETA	685	350	2,5	MDF 2,5MM
23190	2	COSTA	736	350	2,5	MDF 2,5MM
23191	2	TRAVESSA	350	55	25	MDF 25MM
23230	2	PÉ CÔNICO DIREITO	160	83	24	PLÁSTICO
23231	2	PÉ CÔNICO ESQUERDO	160	83	24	PLÁSTICO

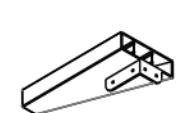
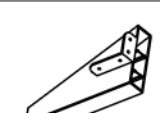
## Lista de Ferragens

<p>Cód: 2521 (x8)</p>  <p>PARAFUSO FLANGEADO 3,5x40</p>	<p>Cód: 2677 (x1)</p>  <p>GIZ CERA</p>	<p>Cód: 2471 (x18)</p>  <p>CAVILHA MADEIRA 6X25</p>	<p>Cód: 2466 (x4)</p>  <p>CANTONEIRA METAL 4 FUROS</p>
<p>Cód: 2505 (x6)</p>  <p>PARAFUSO CABEÇA CHATA 3,5x40</p>	<p>Cód: 10101 (x6)</p>  <p>CONECTOR PLÁSTICO 4 FUROS</p>	<p>Cód: 2503 (x50)</p>  <p>PARAFUSO CABEÇA CHATA 3,5x12</p>	<p>Cód: 21200 (x40)</p>  <p>PARAFUSO FLANGEADO 3,5x12</p>
<p>Cód: 2572 (x40)</p>  <p>PREGO C/ CABEÇA 10X10</p>	<p>Cód: 9052 (x6)</p>  <p>SUPORE TRIANGULAR C/ ABA</p>	<p>Cód: 2473 (x4)</p>  <p>CAVILHA MADEIRA 6X40</p>	<p>Cód: 19501 (x3)</p>  <p>CORREDIÇA TELESCÓPICA 1 ESTÁGIO 350MM</p>
<p>Cód: 23239 (x1)</p>  <p>PERFIL H 25X17 PLÁSTICO 735 MM</p>	<p>Cód: 25787 (x3)</p>  <p>PERFIL PUXADOR MDF 25 x 0,22 x 0,12 MM</p>	<p>Cód: 23230 (x2)</p>  <p>PÉ CÔNICO DIREITO</p>	<p>Cód: 23231 (x2)</p>  <p>PÉ CÔNICO ESQUERDO</p>
<p>Cód: 2520 (x6)</p>  <p>PARAFUSO FLANGEADO 3,5X25</p>	<p>Cód: 14025 (x1)</p>  <p>ETIQUETA TILILIN</p>		

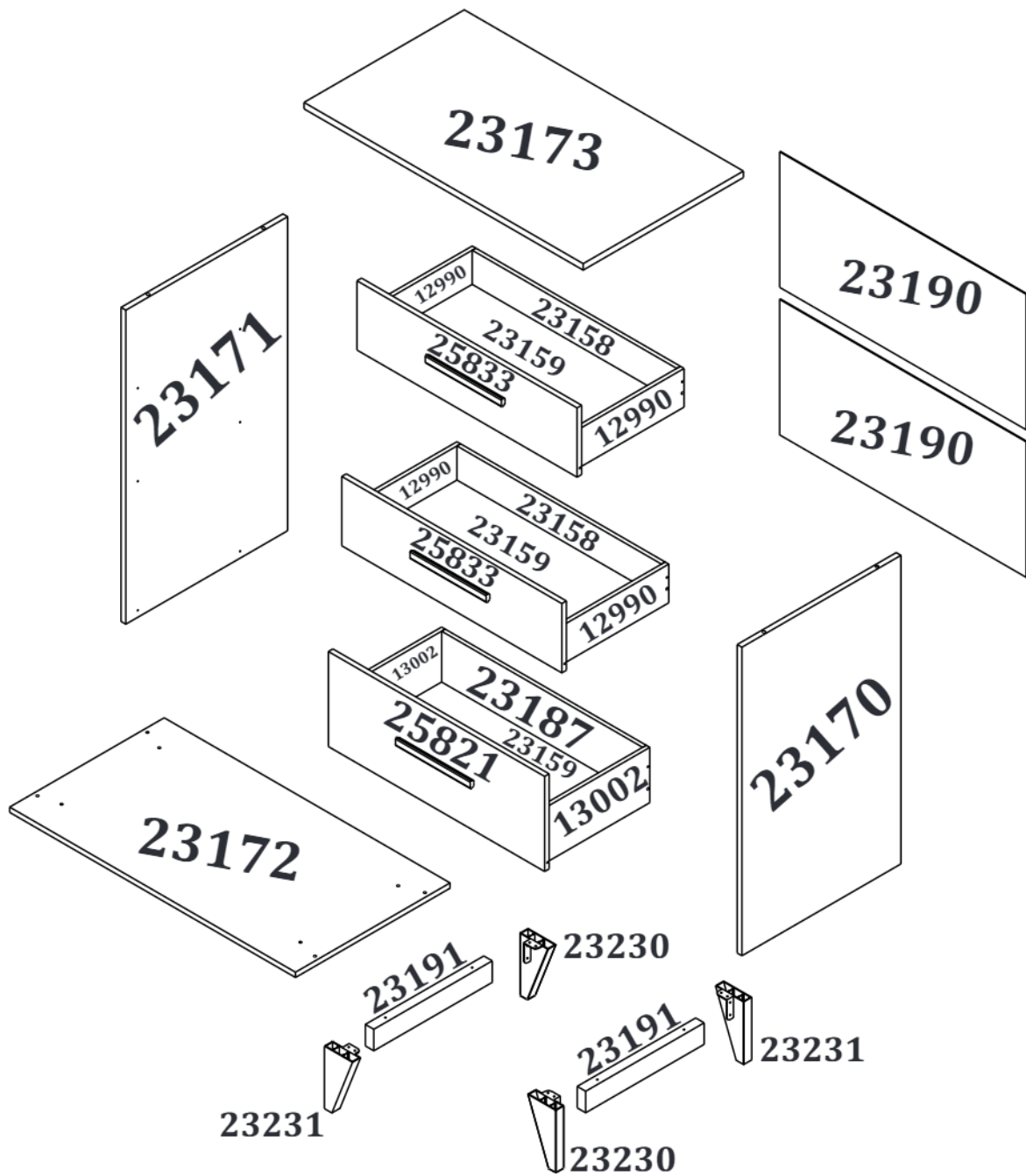

**1** Faça a montagem de acordo com a ilustração abaixo. Fixe os pés ( 23230/ 23231 ) nas travessas ( 23191 ) utilizando os parafusos ( 21200 ). Após montar os pés, fixe a base ( 23172 ) nas travessas utilizando os parafusos ( 2521 ).

